

# Data Sheet



Article number: 021816011250

Description: Clamp with bracket and rubber  
SPGU 6011. 250/30 SK

## Measures

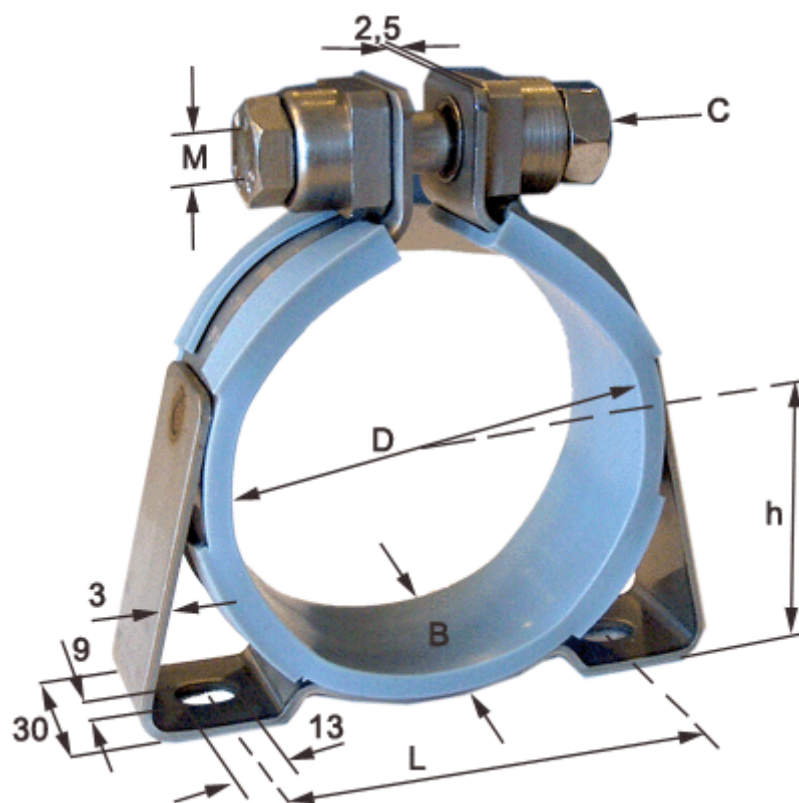

C (screw type) = SK hexagon screw

Diameter D = 250

h = 133

L = 248

Width B = 30